

SINGLE SUPPLY WIDE BAND 3ch VIDEO AMPLIFIER

■ GENERAL DESCRIPTION

The **NJM2580** is a wide band 3ch video amplifier, operated on a single supply voltage. It is suitable for Y, Pb, and Pr signal because frequency range is 50MHz.

The **NJM2580** is suitable for Set Top Box, AV amplifier, and other high quality AV systems.

■ PACKAGE OUTLINE

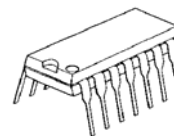

NJM2580D

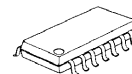

NJM2580M



NJM2580V

■ FEATURES

- Operating Voltage 4.5 to 5.5V
- Wide frequency range 0dB at 50MHz typ.
- Internal 6dB Amplifier
- Internal 75Ω Driver Circuit (2-system drive)
- Power Save Circuit
- Bipolar Technology
- Package Outline DIP14, DMP14, SSOP14

■ BLOCK DIAGRAM

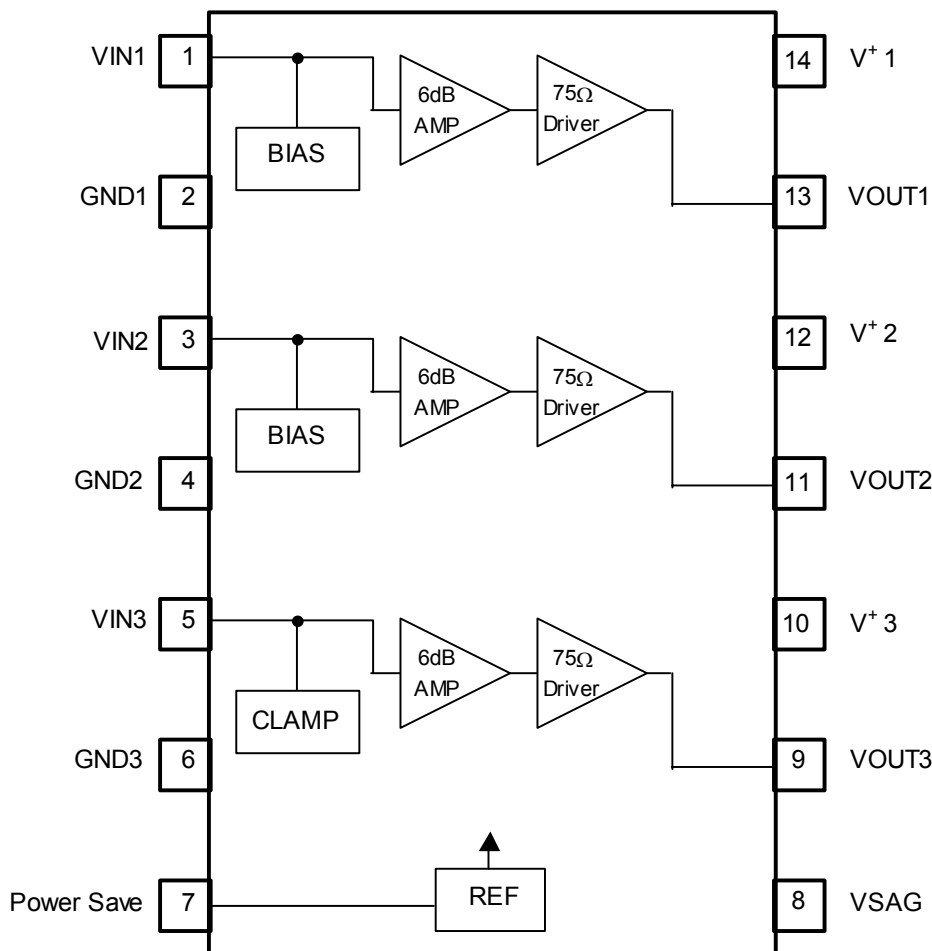

NJM2580

■ ABSOLUTE MAXIMUM RATINGS

(Ta=25°C)

PARAMETERS	SYMBOL	RATINGS	UNIT
Supply Voltage	V ⁺	12.0	V
Power Dissipation	P _D	(DIP) 620 (DMP) 430 (SSOP)520 *	mW
Operating Temperature Range	Topr	-40 to +85	°C
Storage Temperature Range	Tstg	-40 to +150	°C

(Note) At on a board of EIA/JEDEC specification. (114.3 x 76.2 x 1.6mm Two layers, FR-4)

■ ELECTRICAL CHARACTERISTICS

(V⁺=5.0V, R_L=150Ω, Ta=25°C)

PARAMETER	SYMBOL	TEST CONDITION	MIN.	TYP.	MAX.	UNIT
Operating Current	I _{CC}	No signal	-	23.0	33.0	mA
Operating Current (Power Save)	I _{save}	No signal, Power Save	-	-	1.2	mA
Maximum Output Voltage1	V _{om1}	BIAS input Vin=1kHz, Sin signal, THD=1%,	2.4	3.0	-	Vp-p
Maximum Output Voltage2	V _{om2}	CLAMP input Vin=1kHz, Sin signal, THD=1%,	2.2	2.4	-	Vp-p
Voltage Gain	G _v	Vin=1MHz, 1.0Vp-p Sin signal	6.0	6.4	6.8	dB
Band Width	f		-	50	-	MHz
Frequency Characteristic	G _f	Vin=50MHz / 1MHz, 1.0Vp-p, Sin signal	-	0	-	dB
Cross talk 1	CTB1	Vin=4.43MHz, 1.0Vp-p, Sin signal	-	-60	-50	dB
Cross talk 2	CTB2	Vin=50MHz, 1.0Vp-p, Sin signal	-	-40	-	dB
Differential Gain	DG	Vin=1.0Vpp 10step Video signal	-	0.3	-	%
Differential Phase	DP	Vin=1.0Vpp 10step Video signal	-	0.3	-	deg
S/N	SN _v	Vin=1.0Vpp, 100% White Video signal	-	65	-	dB
Power Save Switch Change Voltage H Level	V _{thPH}	IC Operating	2.0	-	V ⁺	V
Power Save Switch Change Voltage L Level	V _{thPL}	IC Waiting	0	-	0.6	V

■ MODE SWITCH FUNCTION

PIN	MODE	NOTES
Power Save	H	Power Save: OFF
	L	Power Save: ON (Mute)
	OPEN	Power Save: ON (Mute)

■ EQUIVALENT CIRCUIT (V+=5V)

PIN No.	NAME	INSIDE EQUIVALENT CIRCUIT	VOLTAGE
1 3	VIN1 VIN2		2.60V
5	VIN3		1.70V
13 11	VOUT1 VOUT2		2.55V
9	VOUT3		1.35V

NJM2580

■ EQUIVALENT CIRCUIT (V+=5V)

PIN No.	NAME	INSIDE EQUIVALENT CIRCUIT	VOLTAGE
7	Power Save		0V
8	VSAG		1.40V
14 12 10	V ⁺ 1 V ⁺ 2 V ⁺ 3		5V
2 4 6	GND1 GND2 GND3		0V

TEST CIRCUIT



NJM2580

APPLICATION CIRCUIT 1



APPLICATION CIRCUIT 2



TYPICAL CHARACTERISTICS

Voltage Gain vs. Frequency

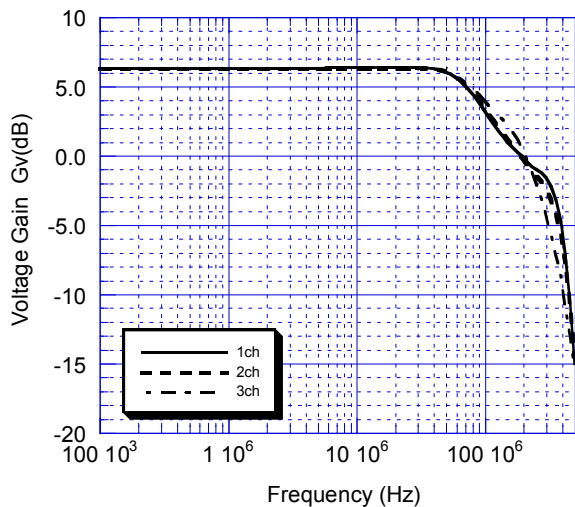

Operating Current vs. Supply Voltage

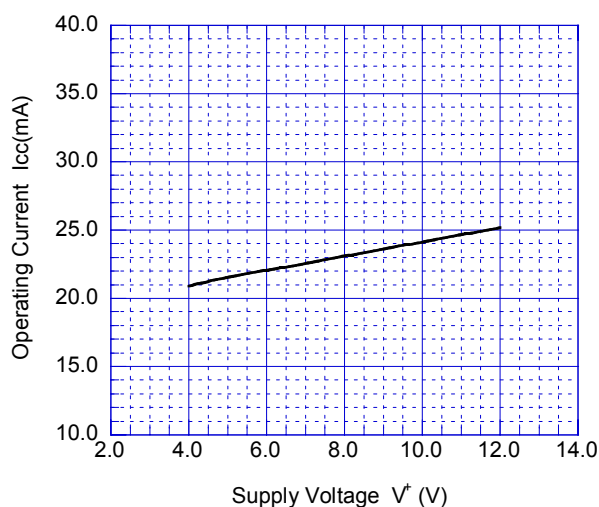

Operating Current at Standby State vs. Supply Voltage

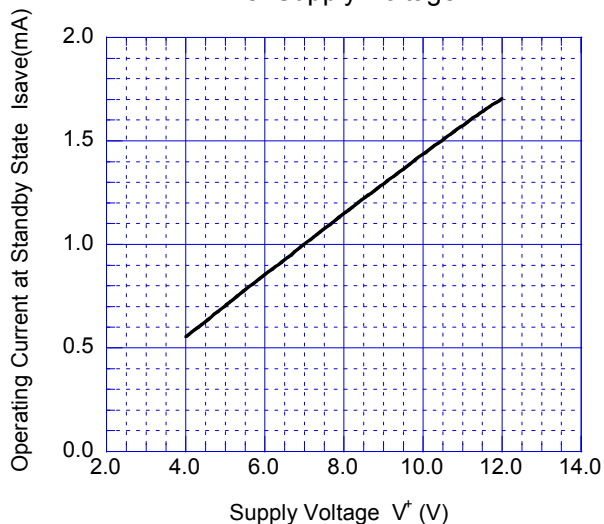

Maximum Output Voltage Swing vs. Supply Voltage (BIAS Type Input)

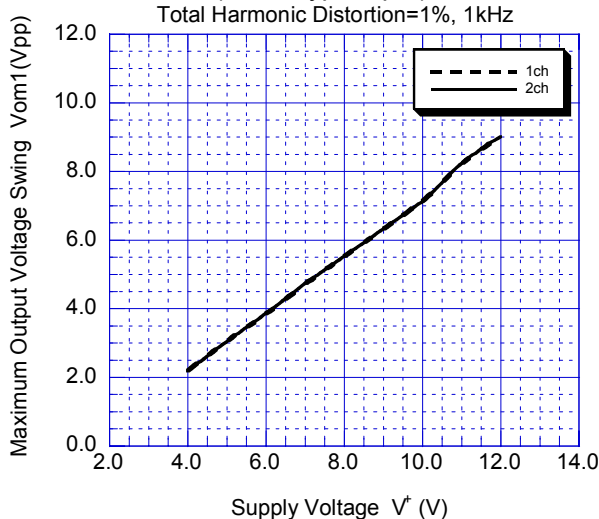

Maximum Output Voltage Swing vs. Supply Voltage (CLAMP Type Input)

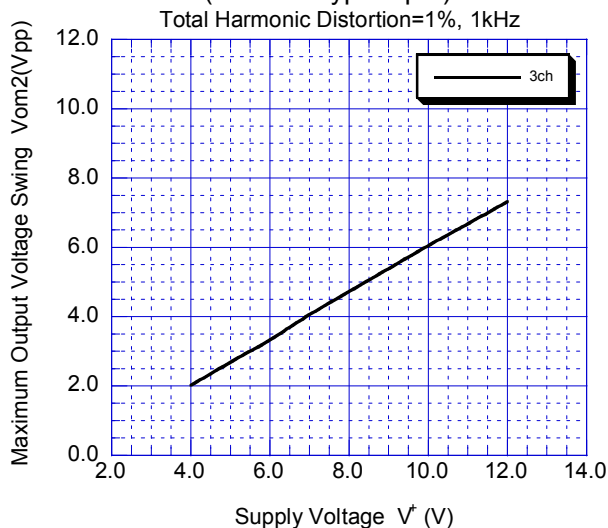

Voltage Gain vs. Supply Voltage

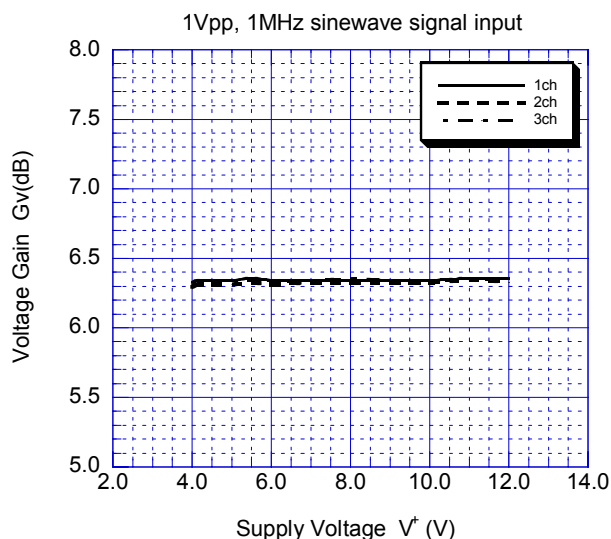

TYPICAL CHARACTERISTICS

Gain Frequency Characteristics vs. Supply Voltage

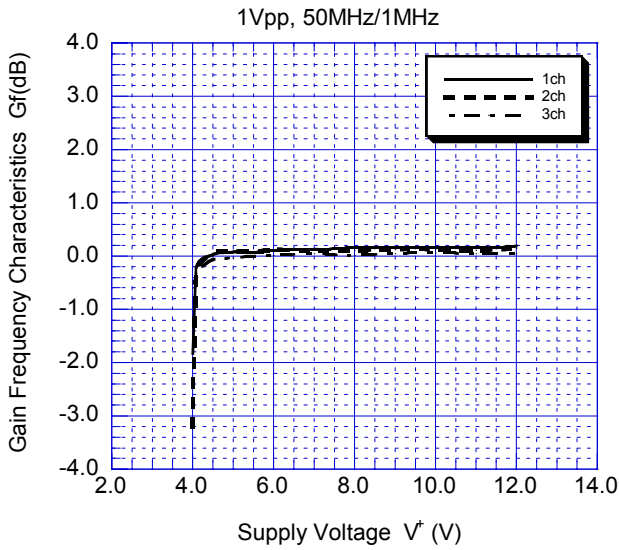

Channel Gain Difference vs. Supply Voltage

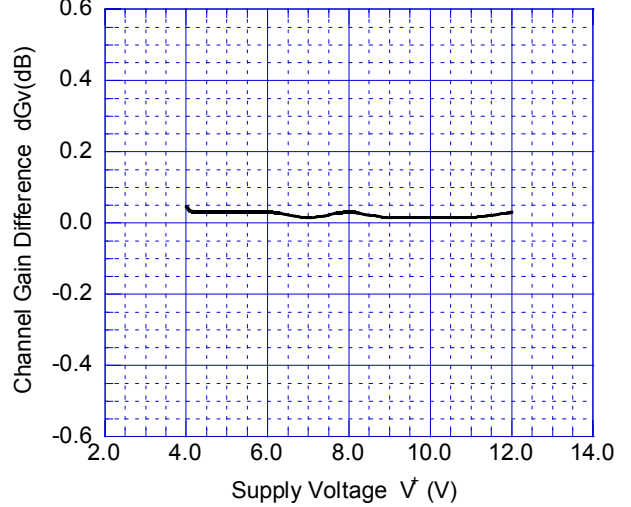

Cross Talk 1 vs. Supply Voltage

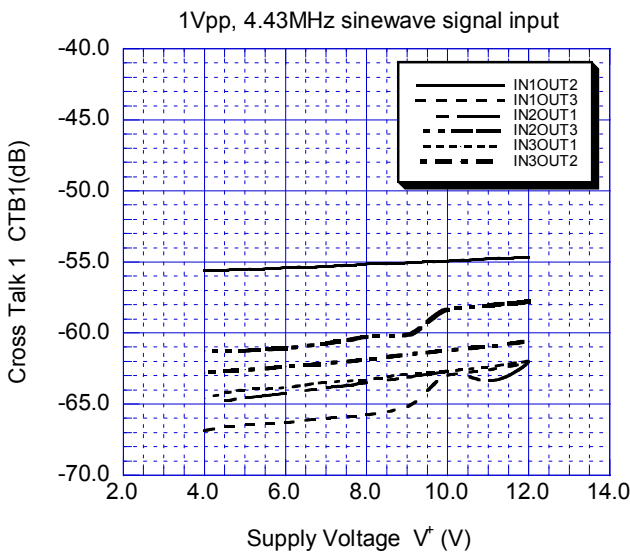

Cross Talk 2 vs. Supply Voltage



Differential Gain vs. Supply Voltage

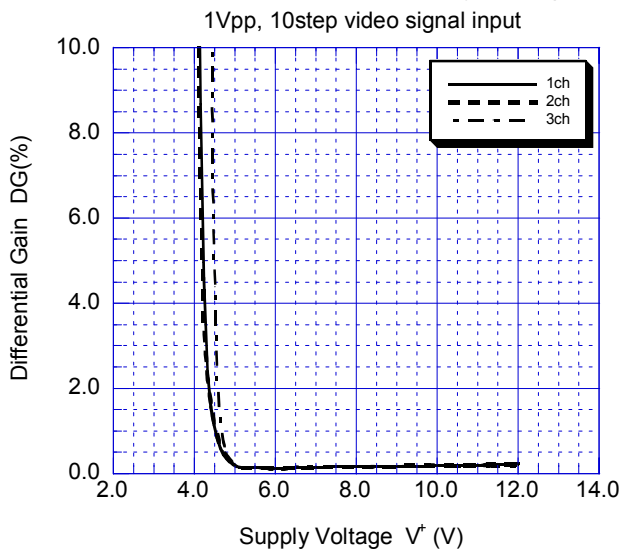

Differential Phase vs. Supply Voltage

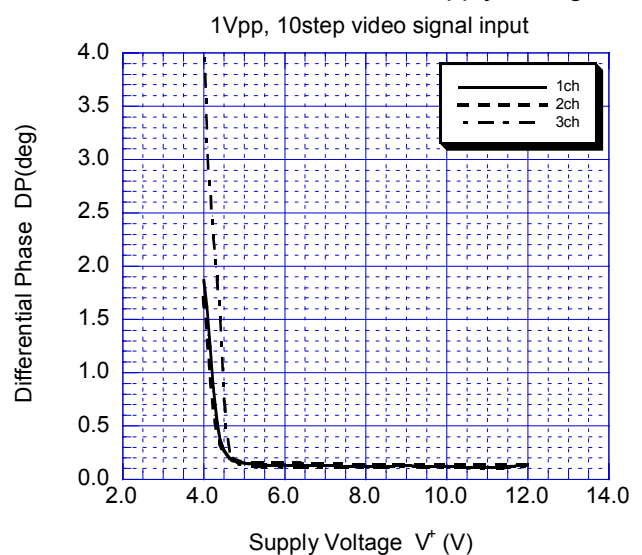

■ TYPICAL CHARACTERISTICS

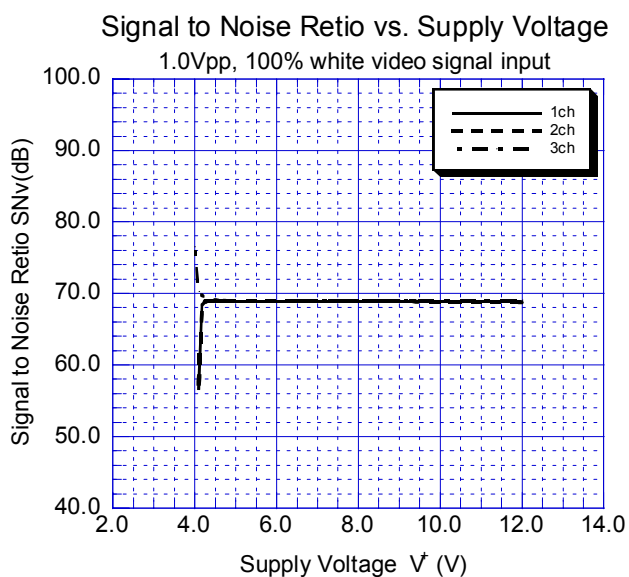

[CAUTION]
The specifications on this data book are only given for information, without any guarantee as regards either mistakes or omissions. The application circuits in this data book are described only to show representative usages of the product and not intended for the guarantee or permission of any right including the industrial rights.